

WEIGHT: 000 LBS.
 CAPACITY: 00 GALLONS
 NOTE: Not to Scale. All dimensions are based on manufacturers and industry standards of $\pm 3/8$ inch.

UPDATED: 07/07

$1/2$ "W x 1"D Tile Flange Lip
 $1 1/2$ "W x $1/2$ "D Threshold Flange

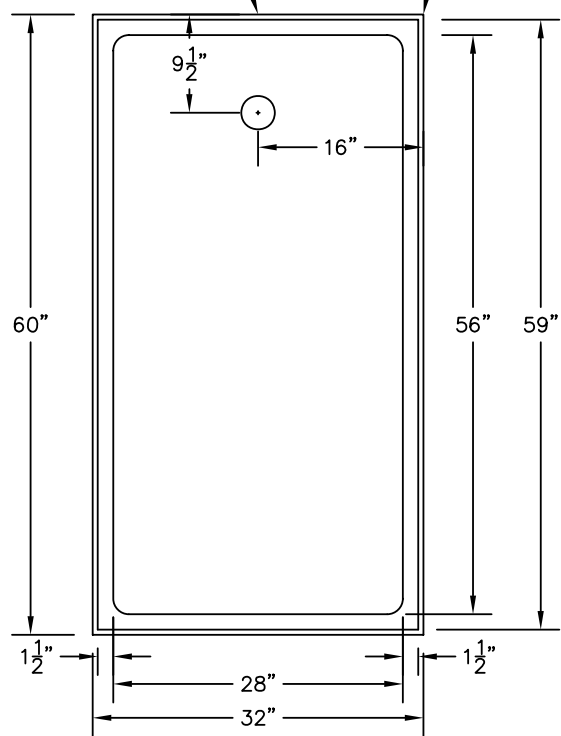

TOP VIEW

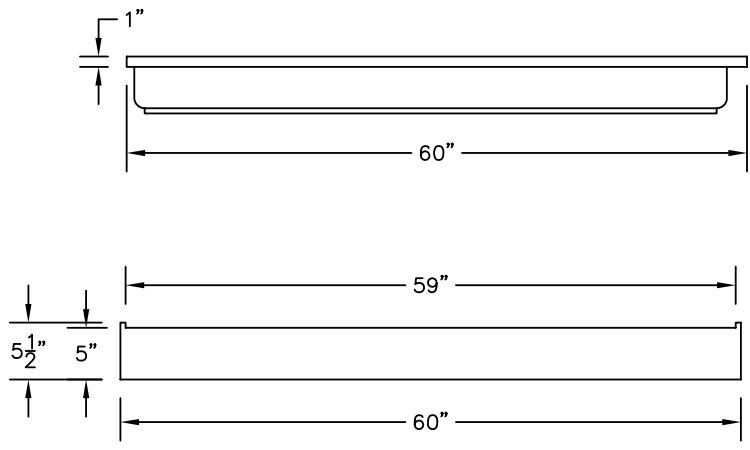

END VIEWS

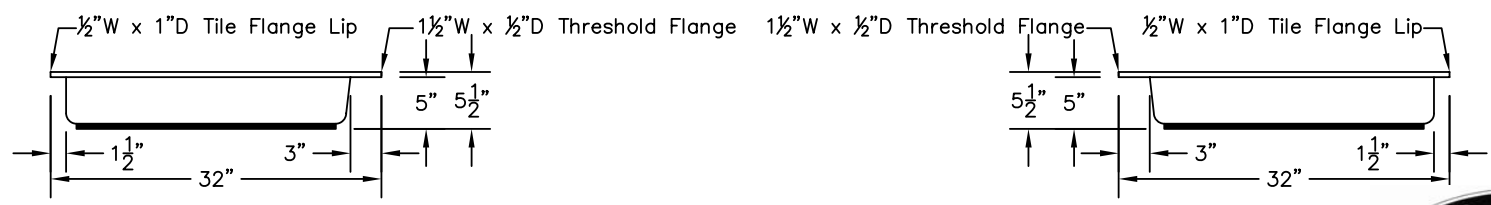

SIDE VIEWS



60" x 32" SHOWER BASE