

WEIGHT: 000 LBS.  
 CAPACITY: 00 GALLONS  
 NOTE: Not to Scale. All dimensions are based  
 on manufacturers and industry standards  
 of  $\pm 3/8$  inch.

UPDATED: 07/07

$1/2$ "W x 1"D Tile Flange Lip  
 $1 1/2$ "W x  $1/2$ "D Threshold Flange

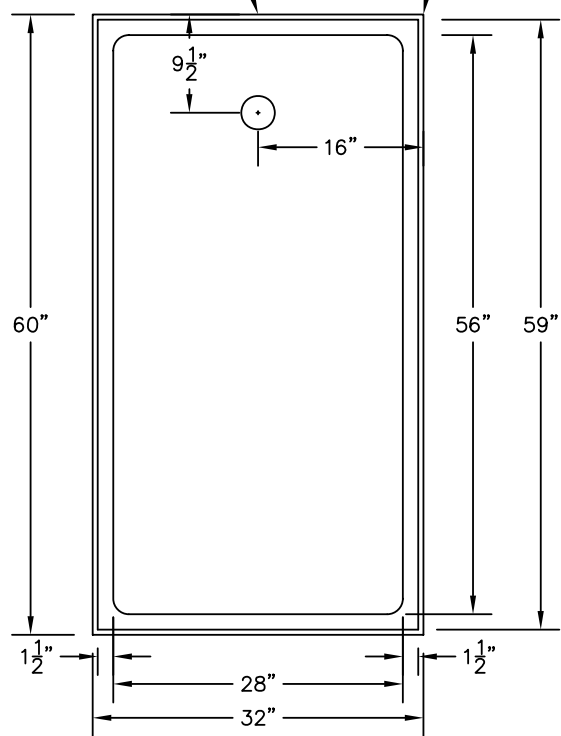

TOP VIEW

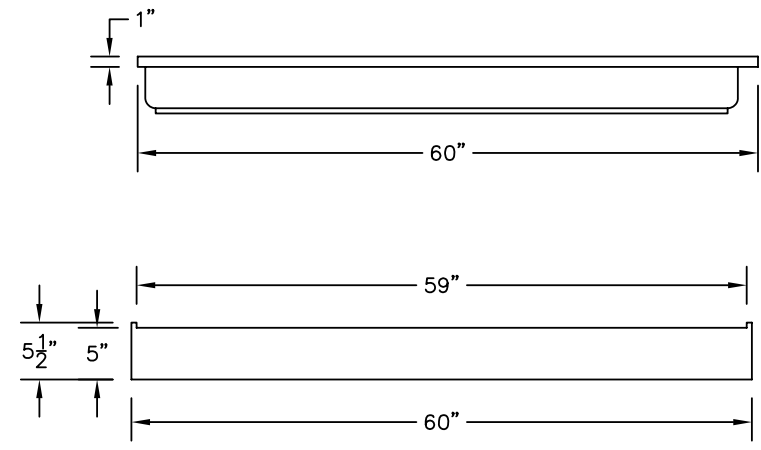

END VIEWS

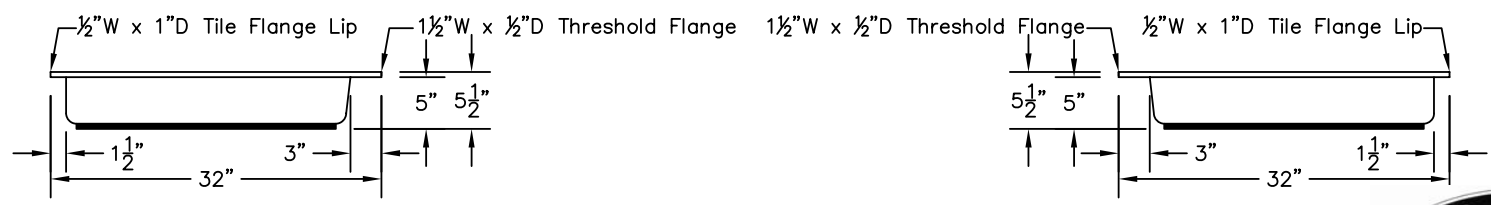

SIDE VIEWS



**60" x 32" SHOWER BASE**